

面板背视

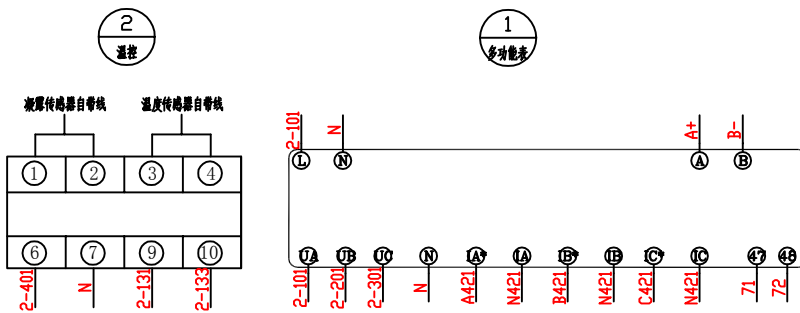

③ 3只150A 断路器

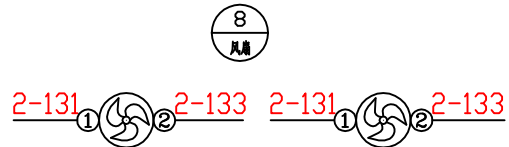
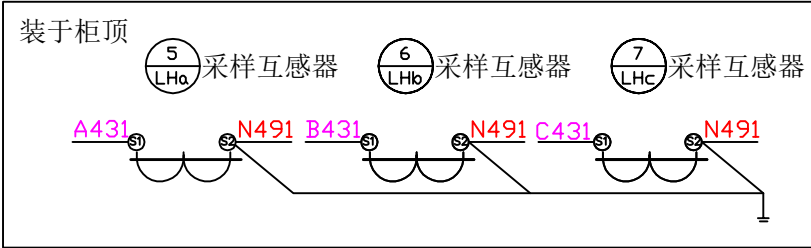
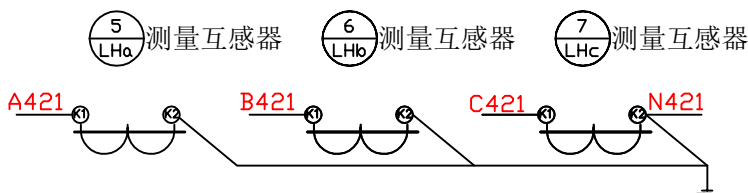
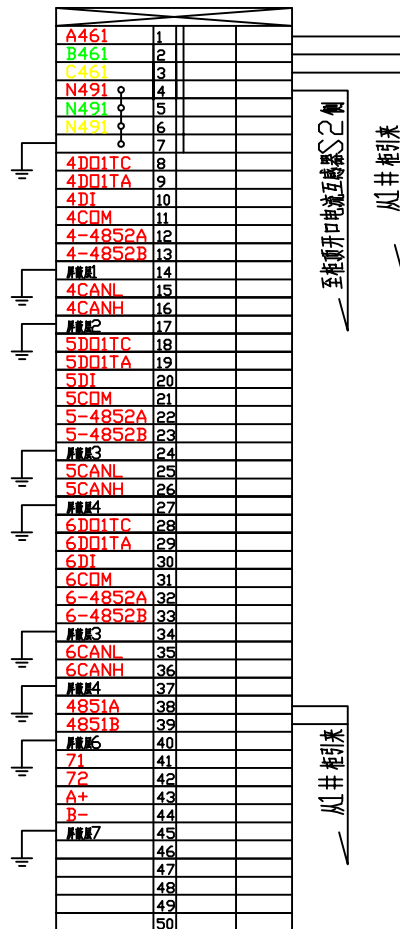
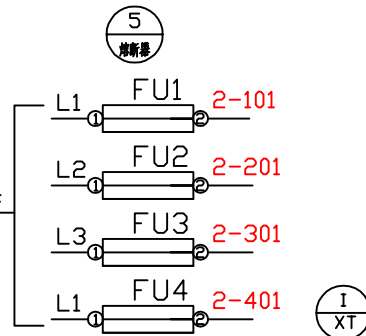
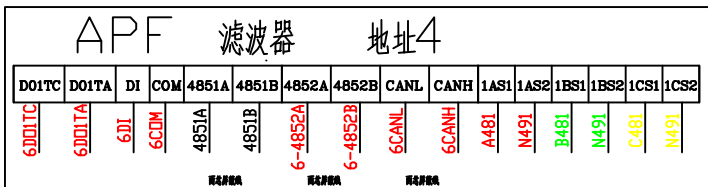
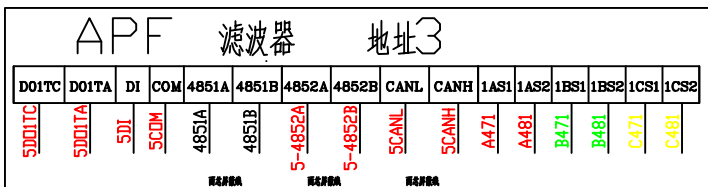
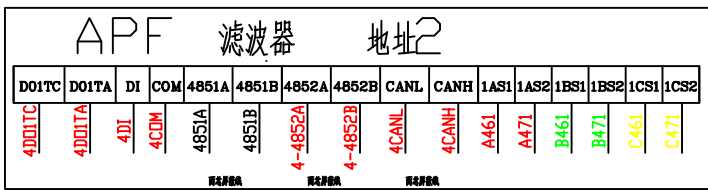

APF 2#柜			滤波柜接线图	
			301LP2308、301LP2404	
批准		设计		
审核		制图		
校核		日期	2023.8	图号

由 Autodesk 教育版产品制作