

面板背视

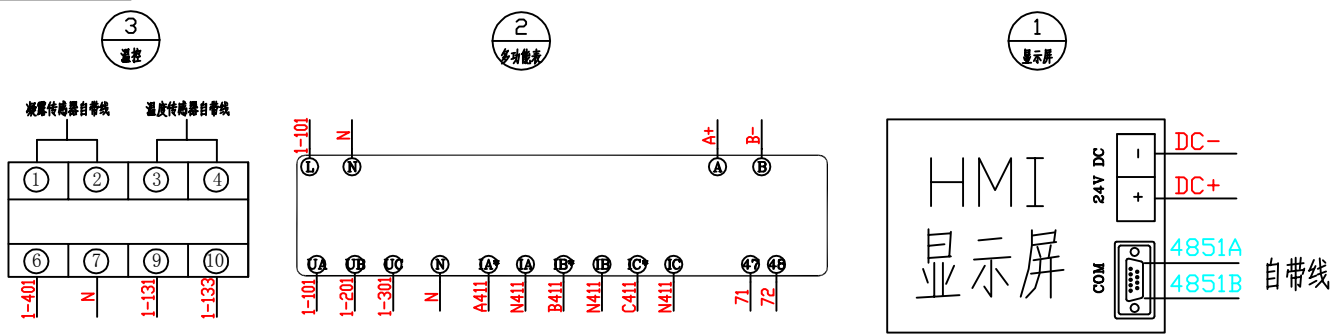

④ SVG 4x100Kvar

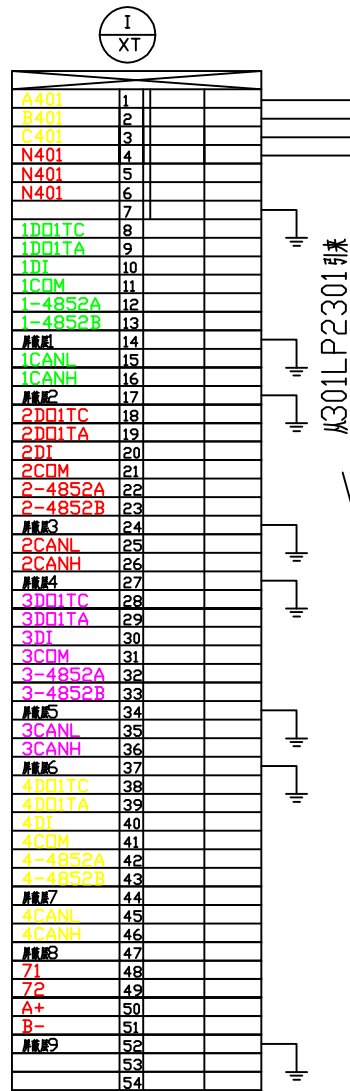
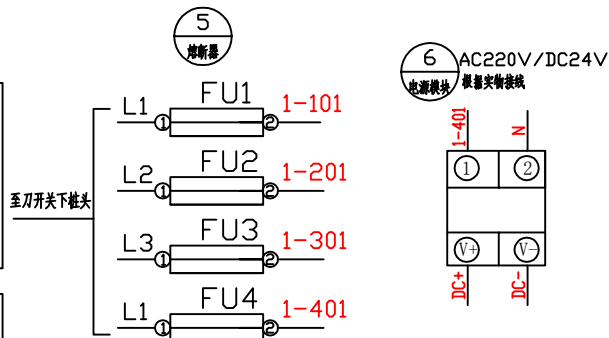
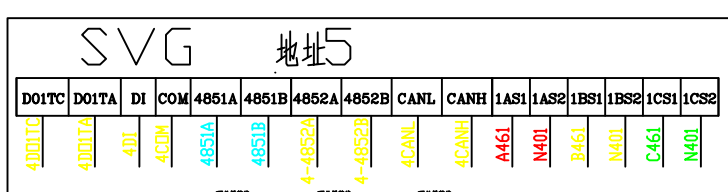
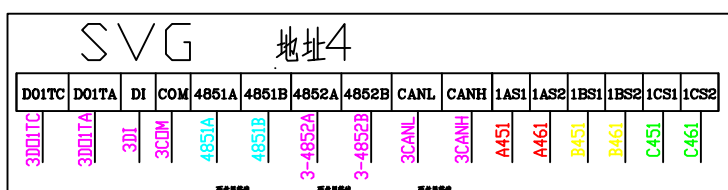
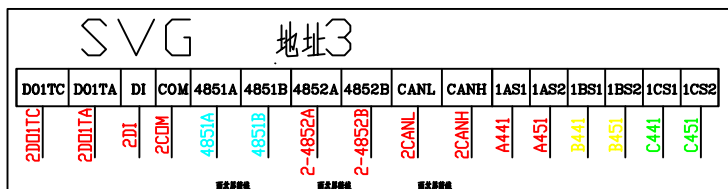
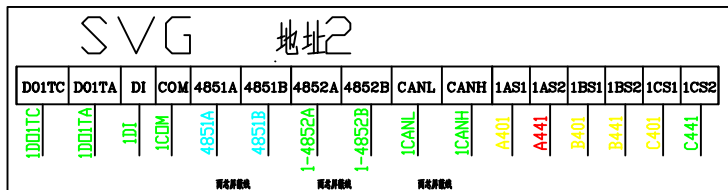

⑦ LHa 测量互感器 ⑧ LHb 测量互感器 ⑨ LHC 测量互感器

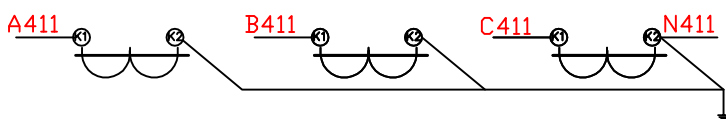

装于301LP2301进线柜

⑤ LHa 采样互感器 ⑥ LHb 采样互感器 ⑦ LHC 采样互感器

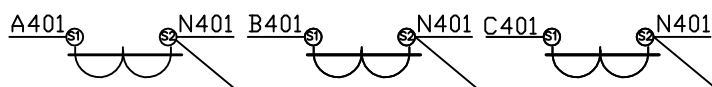

⑩ 风扇

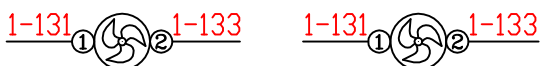

23排列 SVG柜			
无功补偿柜接线图			
301LP2309			
批准	设计	日期	2025.1
审核	制图	图号	
校核	日期	图号	