

面板背视

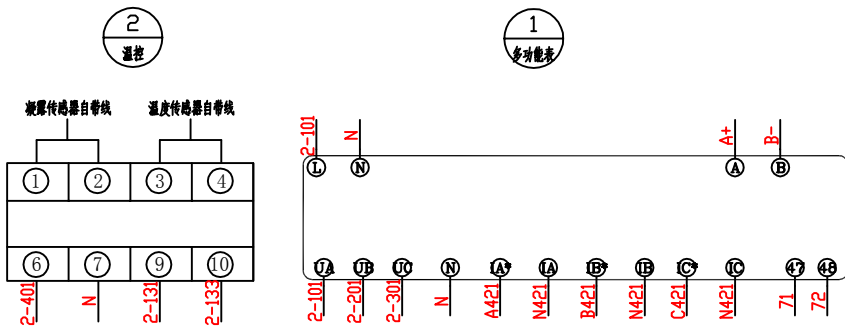

③ 滤波器 3x150A

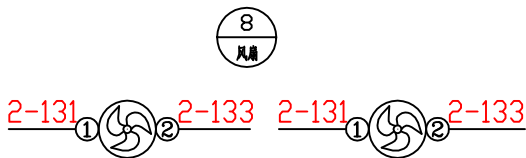
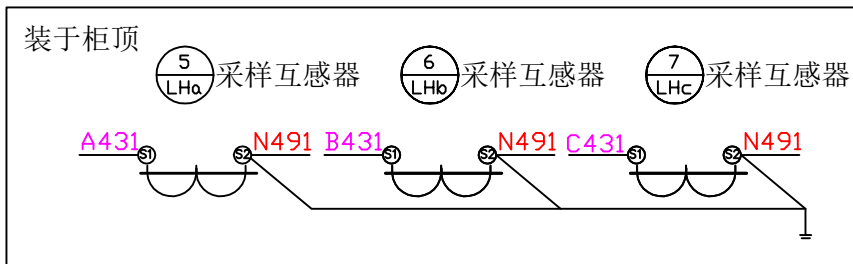
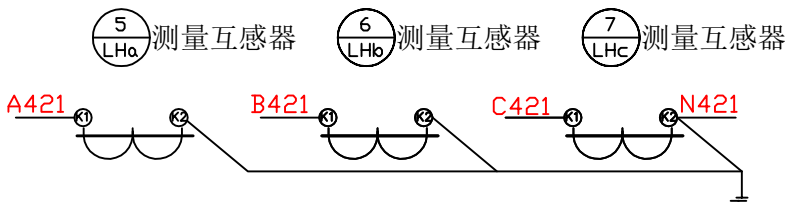
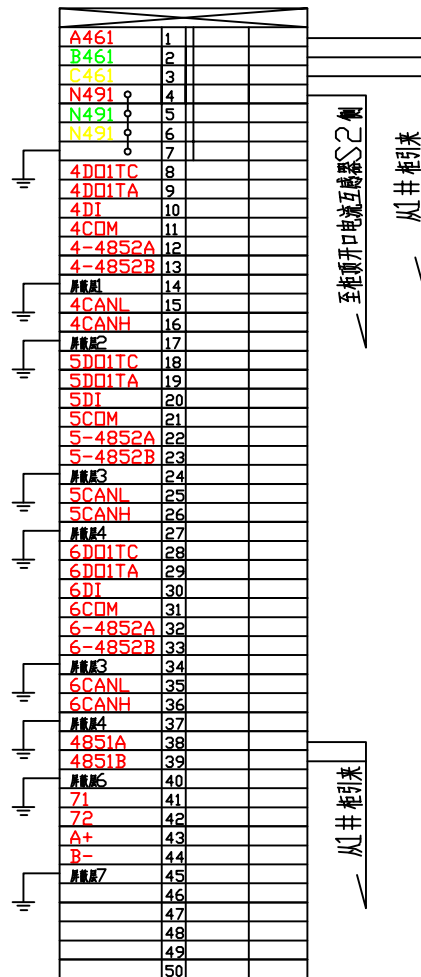
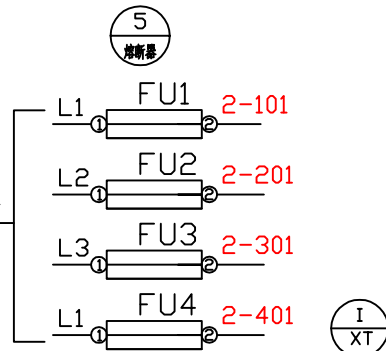
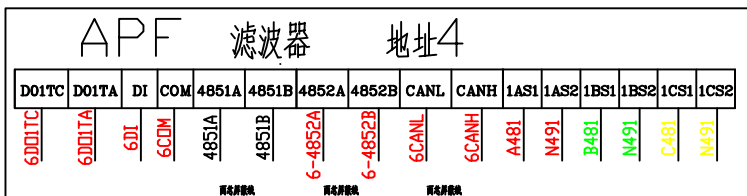
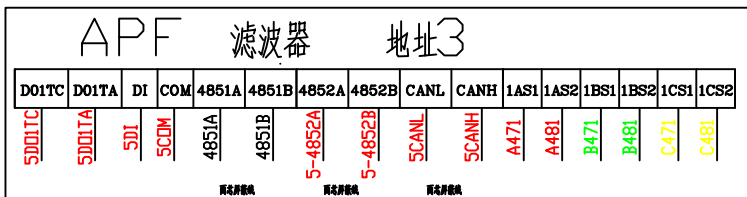
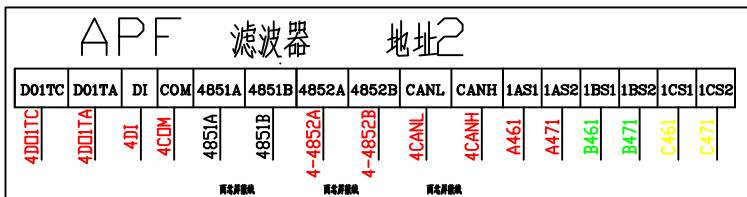

				APF 2#柜	
批准		设计		滤波柜接线图	
审核		制图		301LP2308、301LP2404	
校核		日期	2023.8	图号	